

JVC

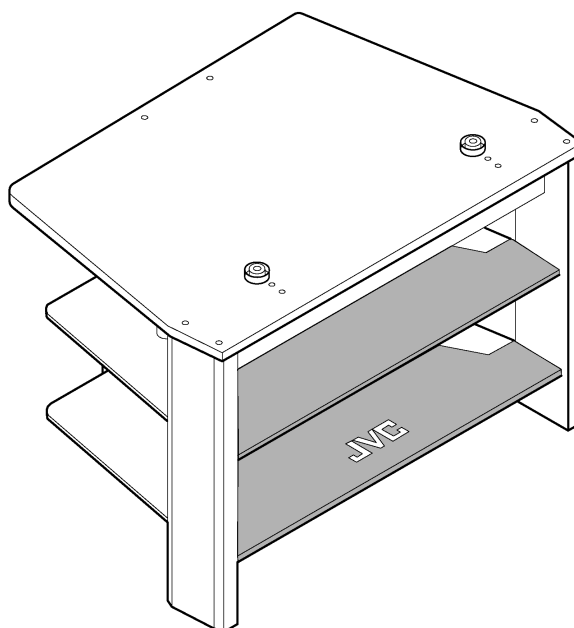













SERVICE MANUAL

TV STAND

RK-C32WF2S/A

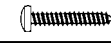

FIXING KIT

A  (X12)	B  (X8)	C  (X8)	D  (X4)	E1  (X4)	E2  (X4)	F  (X3)	G  (X4)	H  (X4)	I  (X6)	J  (X8)	K  (X4)	L  (X2)	M (X4)  TOOL  (X1)
--	---	---	---	--	--	---	---	---	---	---	--	---	---

EXPLODED VIEW

PARTS LIST

△	Ref. No.	Parts No.	Parts Name	Qty	Description
	1	AEM2136-001A-E	LEFT PROFILE	1	
	2	AEM2137-001A-E	RIGHT PROFILE	1	
	3	AEM2112-001A-E	BACK PROFILE	1	
	4	AEM2138-001A-E	FRONT RAIL	1	
	5	AEM2139-001A-E	BACK RAIL	1	
	6	AEM2140-001A-E	REAR BRACE	4	
	7	AEM2141-001A-E	FRONT BRACE	2	
	8	AEM2117-001A-E	FIBRE BOARD BACK	1	
	9	AEM2142-001A-E	SHAPED GLASS	1	Printed JVC Logo
	10	AEM2143-001A-E	SHAPED GLASS	1	
		AEM3183-001A-E	ASSEMBLY INSTRUCTION	1	
		AEM3184-001A-E	MACHINE FIXING KIT. CONTAINING	1	C E G H I J M
		AEM3185-001A-E	HAND FIXING KIT. CONTAINING	1	F N
		AEM3186-001A-E	HAND FIXING KIT. CONTAINING	1	A B D K L

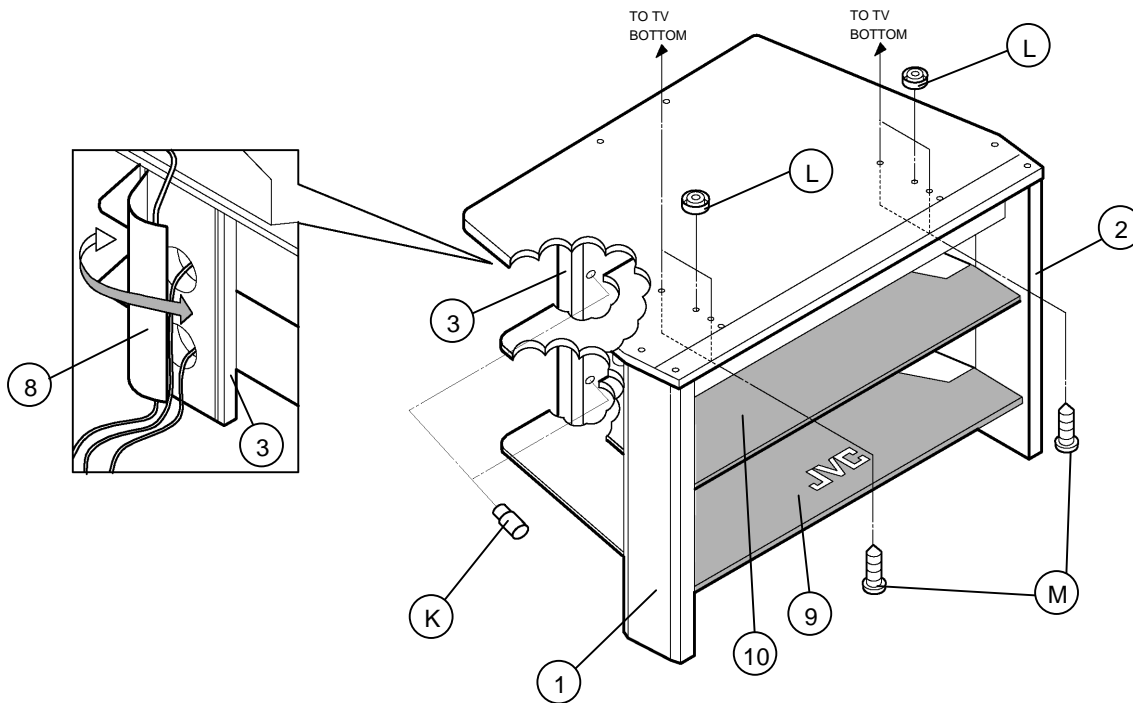

JVC

VICTOR COMPANY OF JAPAN, LIMITED

PROJECTION & SYSTEM NETWORK BUSINESS UNIT 12, 3-chome, Moriya-cho, Kanagawa-ku, Yokohama, Kanagawa-prefecture, 221-8528, Japan



VP 0111
DP1059